

CATÉGORIE: SIMPLE MASC BENJ

ÉCOLE: GR RIV

HEURE: 8h30

POINTAGE: 1 MATCH 21 pts
SANS PROL

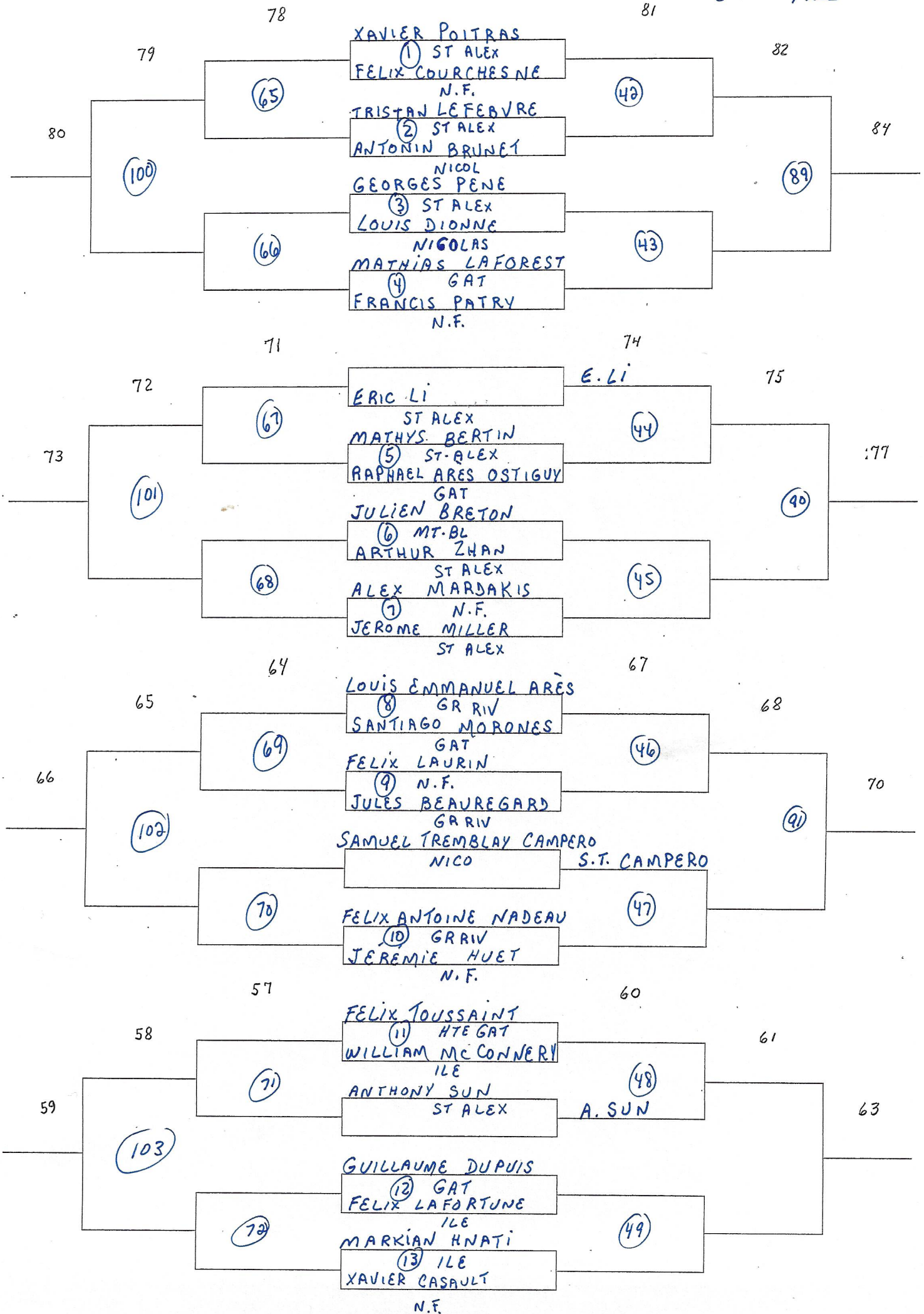

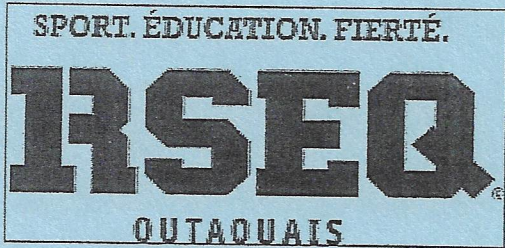

CATÉGORIE: SIMPLE MASC BENJ

ÉCOLE: GR. RIV

HEURE: 8h30

POINTAGE: 1 MATCH 21 pts
SANS POOL

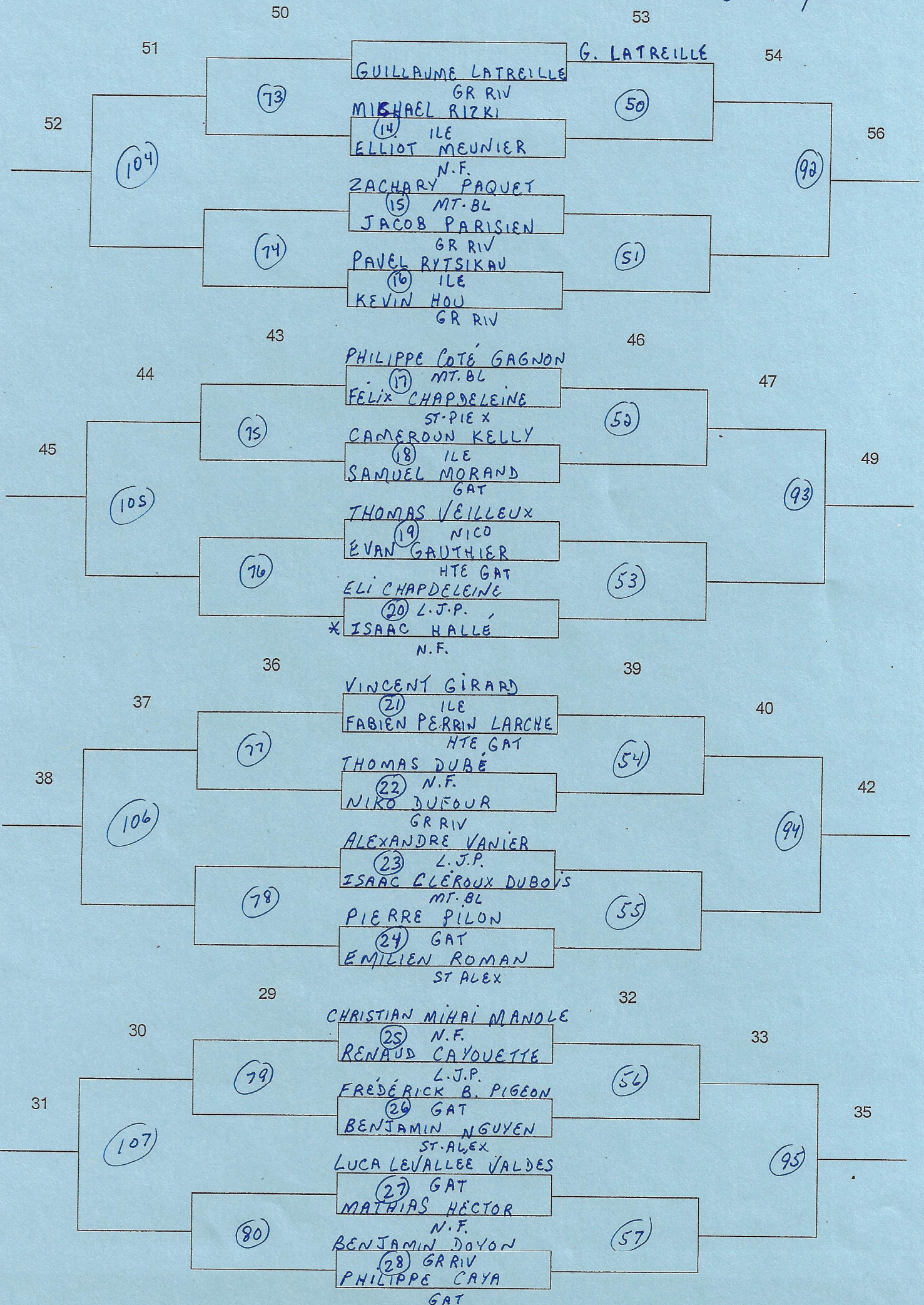

SPORT. ÉDUCATION. FIERTÉ.

RSEQ

OUTAOUAIS

CATÉGORIE: SIMPLE MASC BENJ

ÉCOLE: GRANDE RIV

HEURE: 8h30

POINTAGE: 1 MATCH 21 pts
SANS PADL

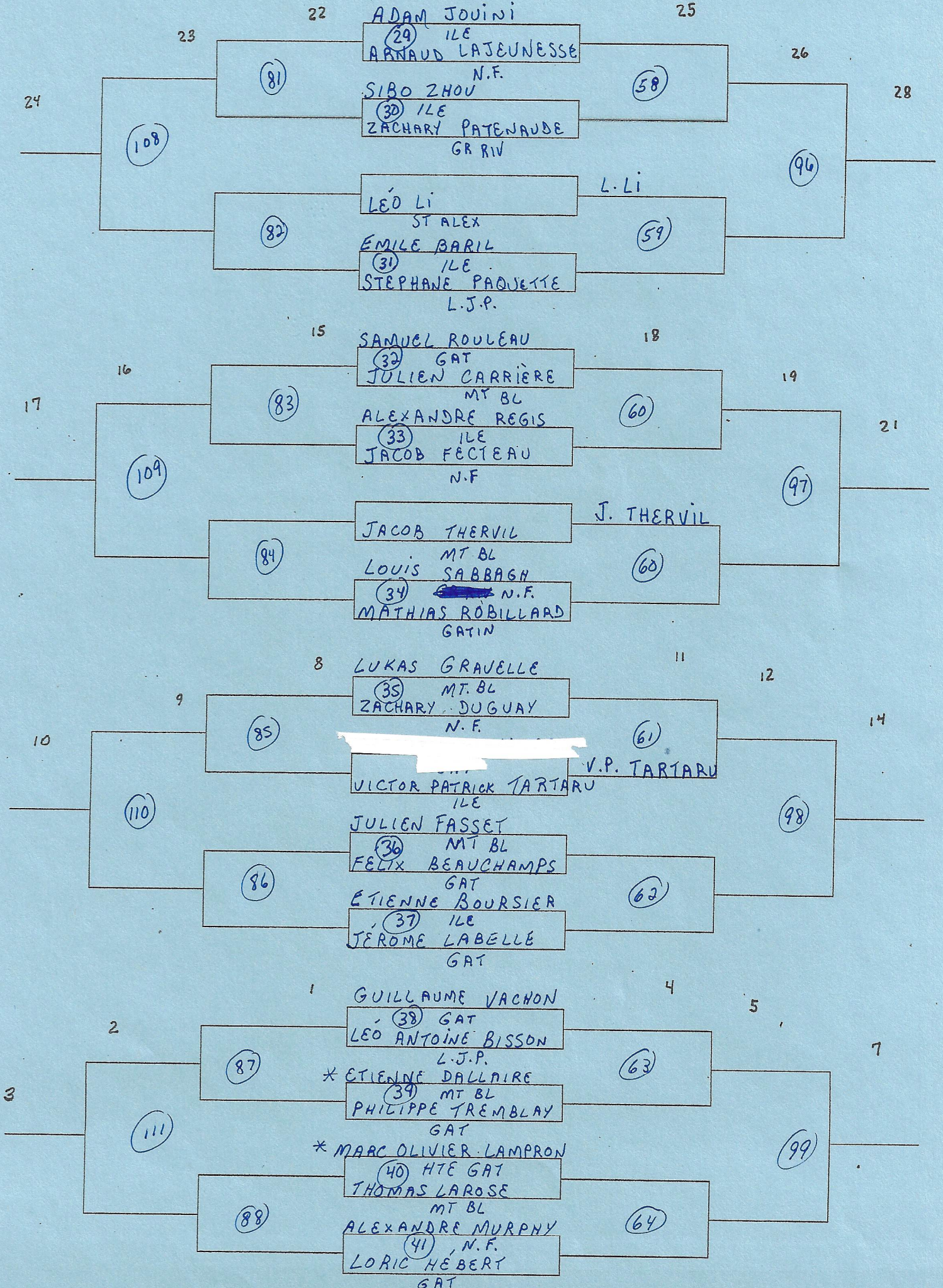

SPORT. ÉDUCATION. FIERTÉ.

RSEQ

OUTAOUAIS

CATÉGORIE: DOUBLE MASC BÉN J

ÉCOLE: GR. RIV

HEURE:

POINTAGE: 1 MATCH 21 pts
SANS PROL

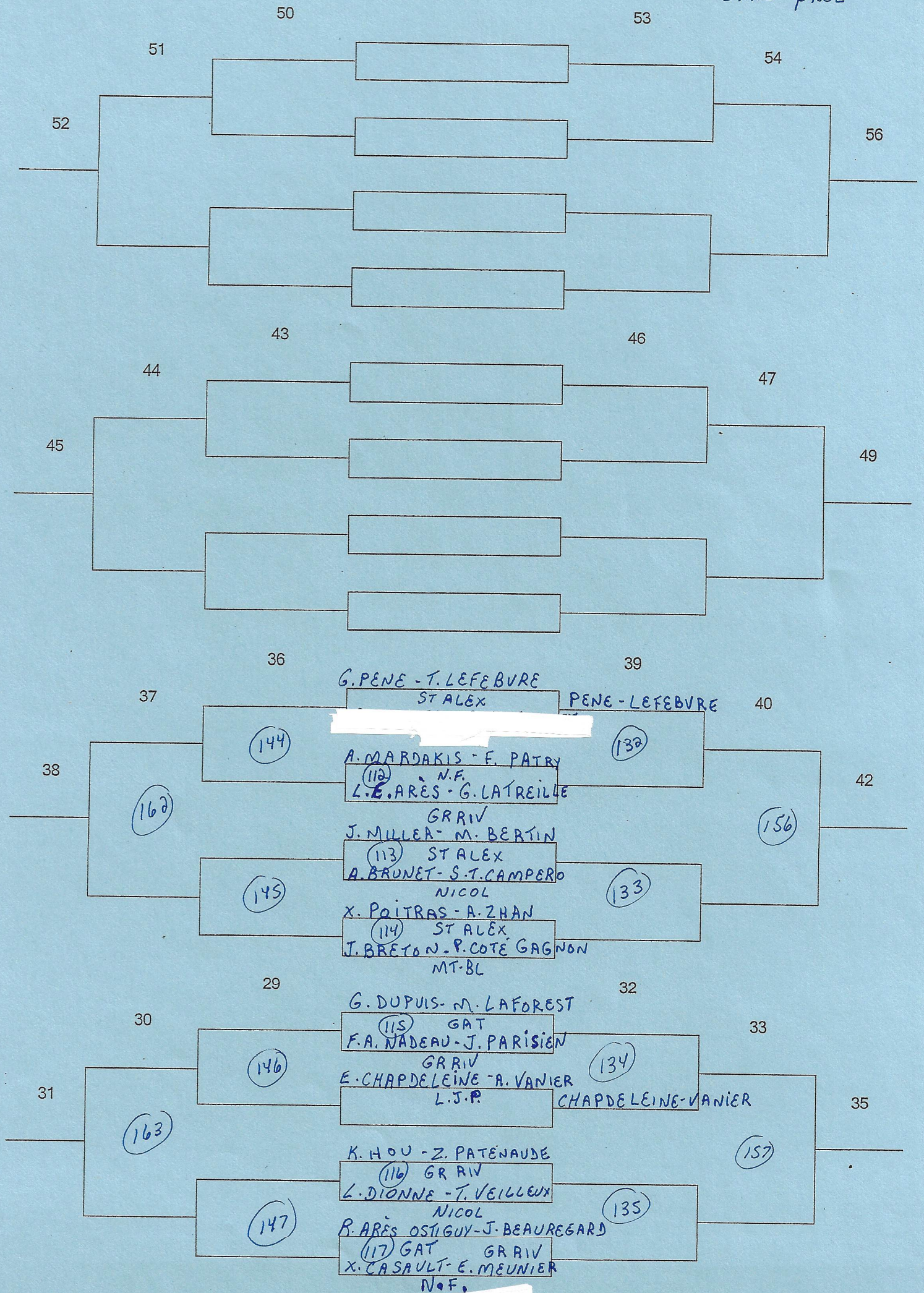

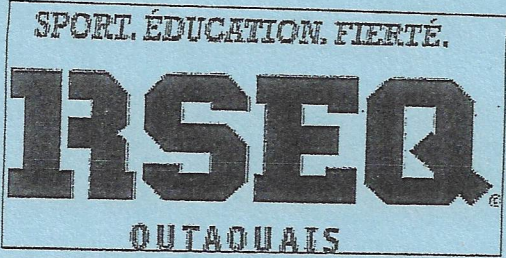

CATÉGORIE: DOUBLE MASC BENS

ÉCOLE: GR. RIV

HEURE:

POINTAGE: 1 MATCH 21 pts
SANS PROL

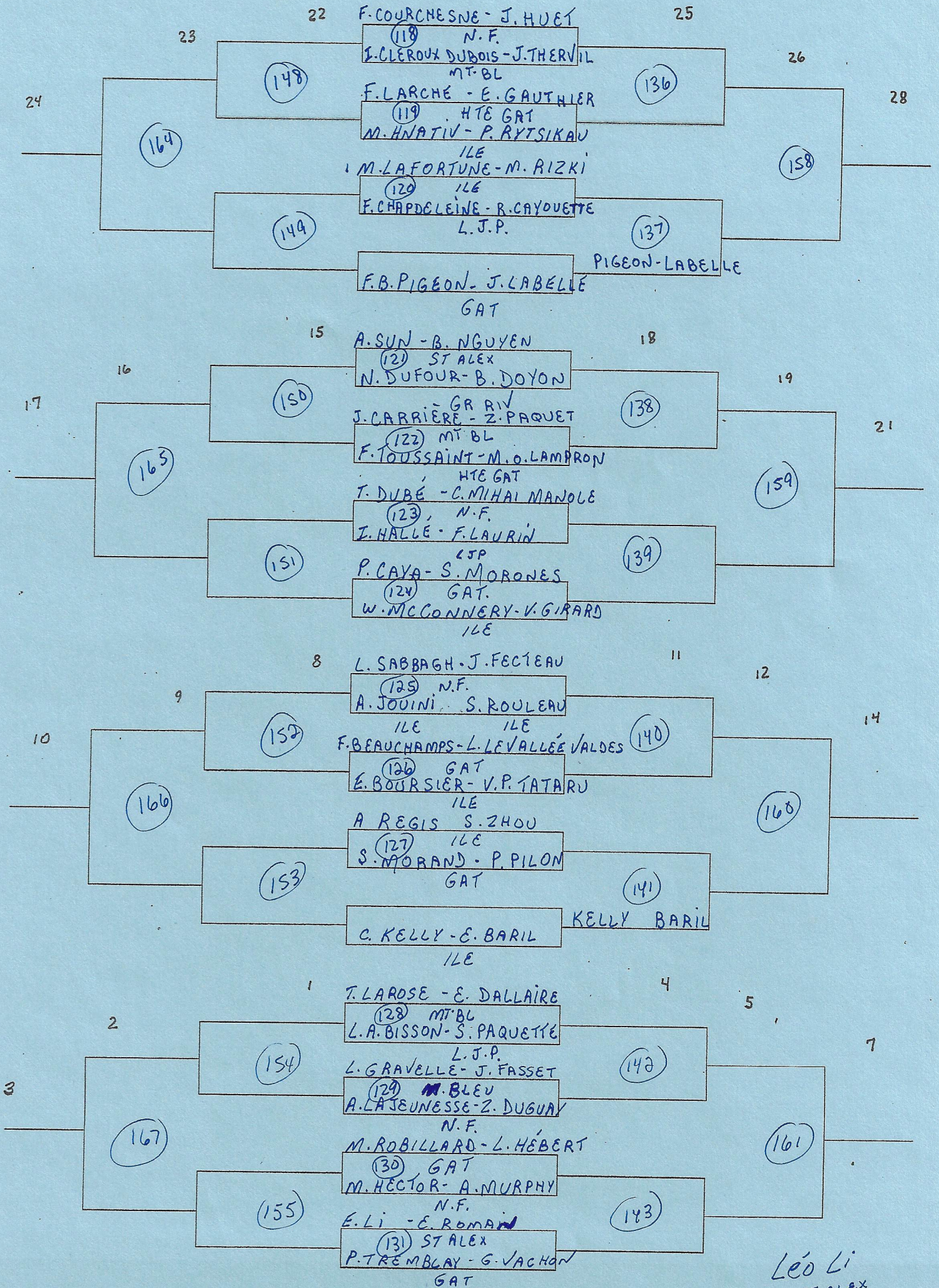

Léo Li
ST ALEX

SPORT. ÉDUCATION. FIERTÉ.

RSEQ

OUTAOUAIS

CATÉGORIE: DOUBLE MIXTE BENJ

ÉCOLE: GR RIV

HEURE: 12h30

POINTAGE: 1 MATCH 21 pts

SANS PROL

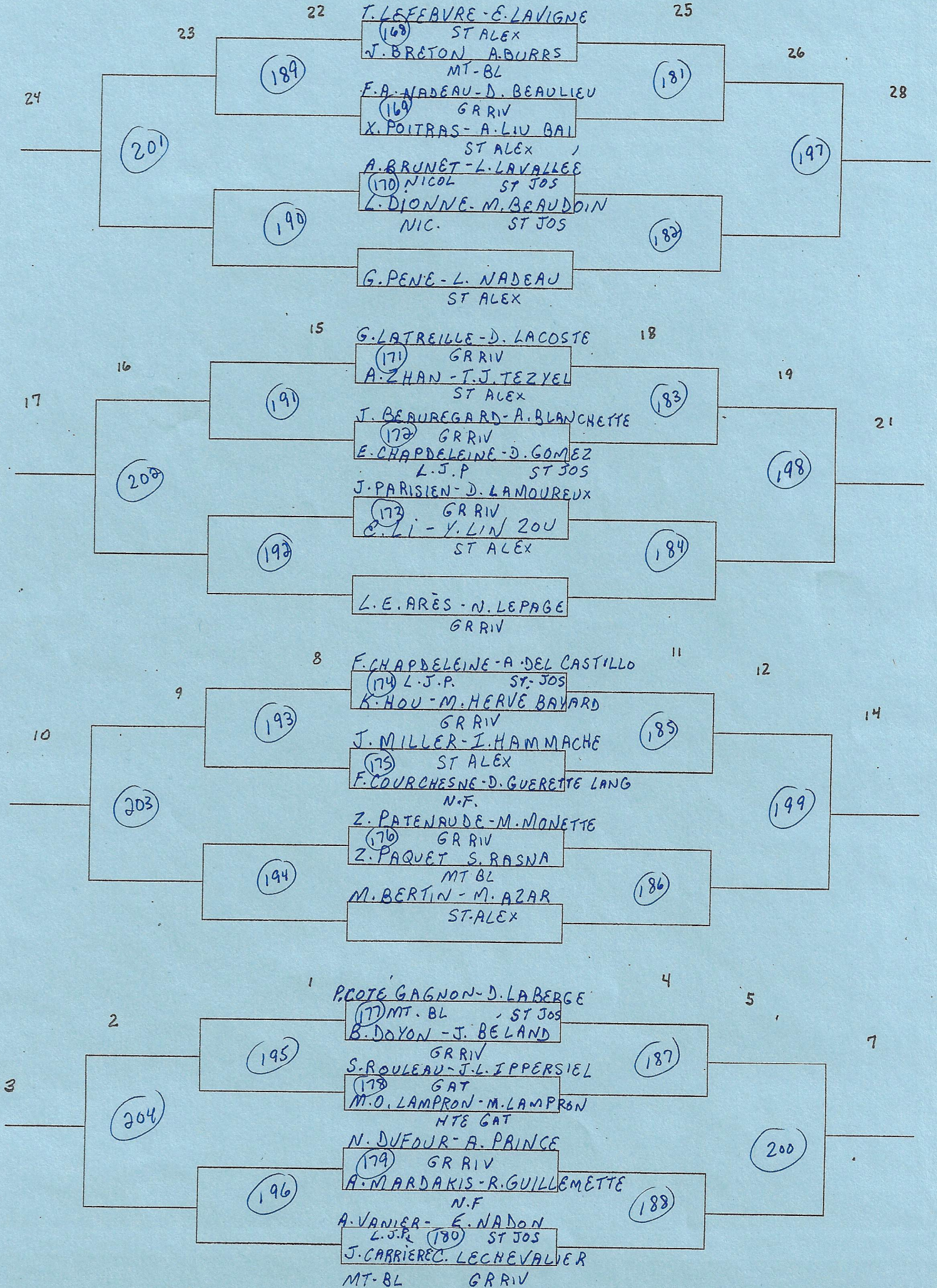

SPORT. ÉDUCATION. FIERTÉ.



CATÉGORIE: SIMPLE FÉM BENJ

ÉCOLE: GR RIV

HEURE: 13h45

POINTAGE: 1 MATCH 21 pts
SANS PROL

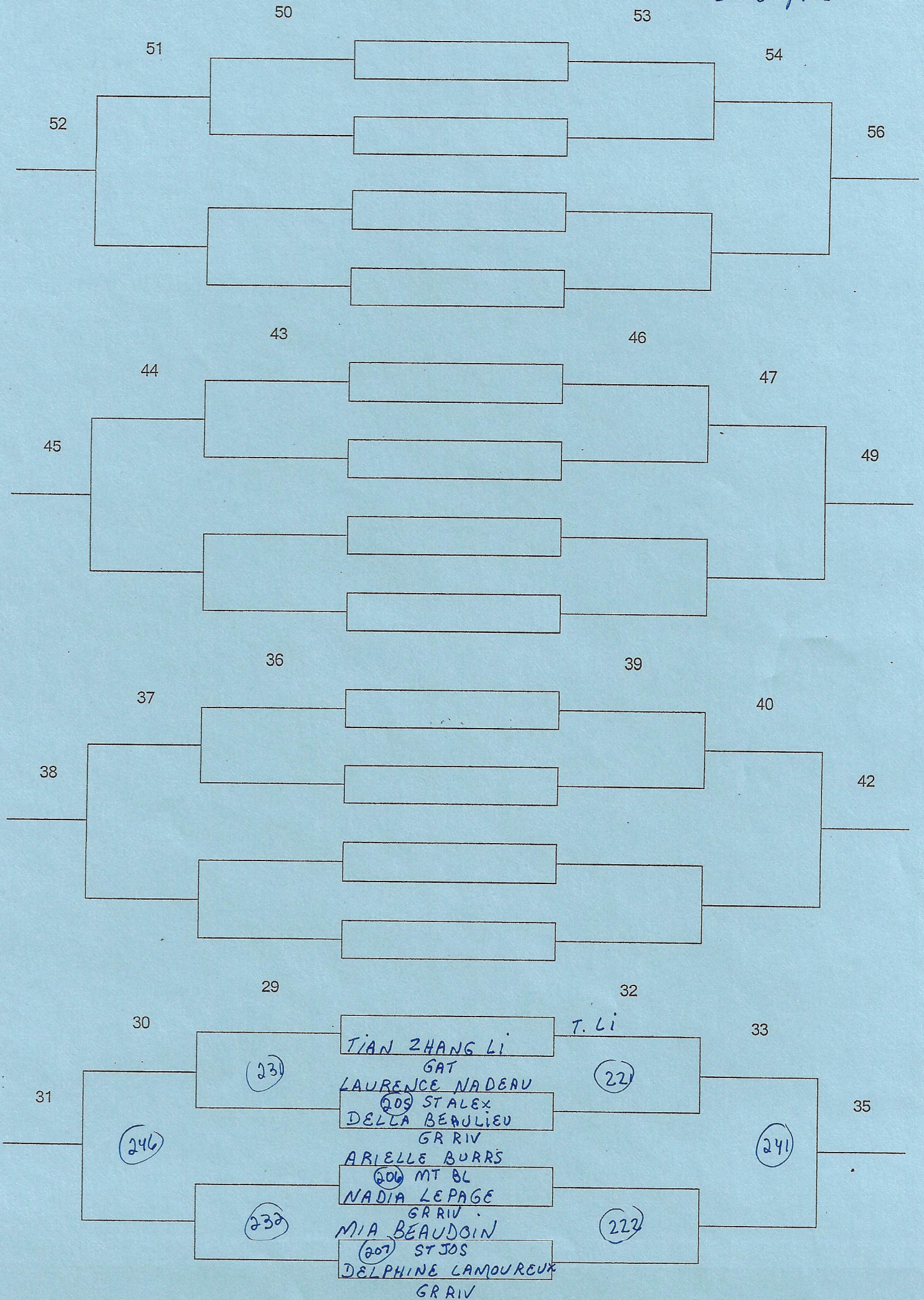

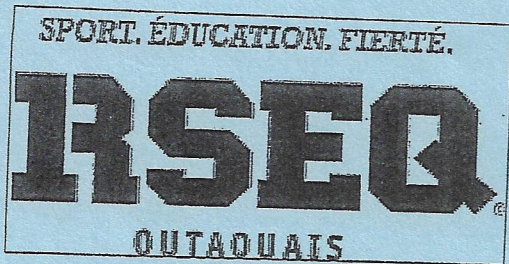

CATÉGORIE: SIMPLE FÉM BENJ

ÉCOLE: GR RIV

HEURE: 13h45

POINTAGE: 1 MATCH 21 pts
SANS PROL

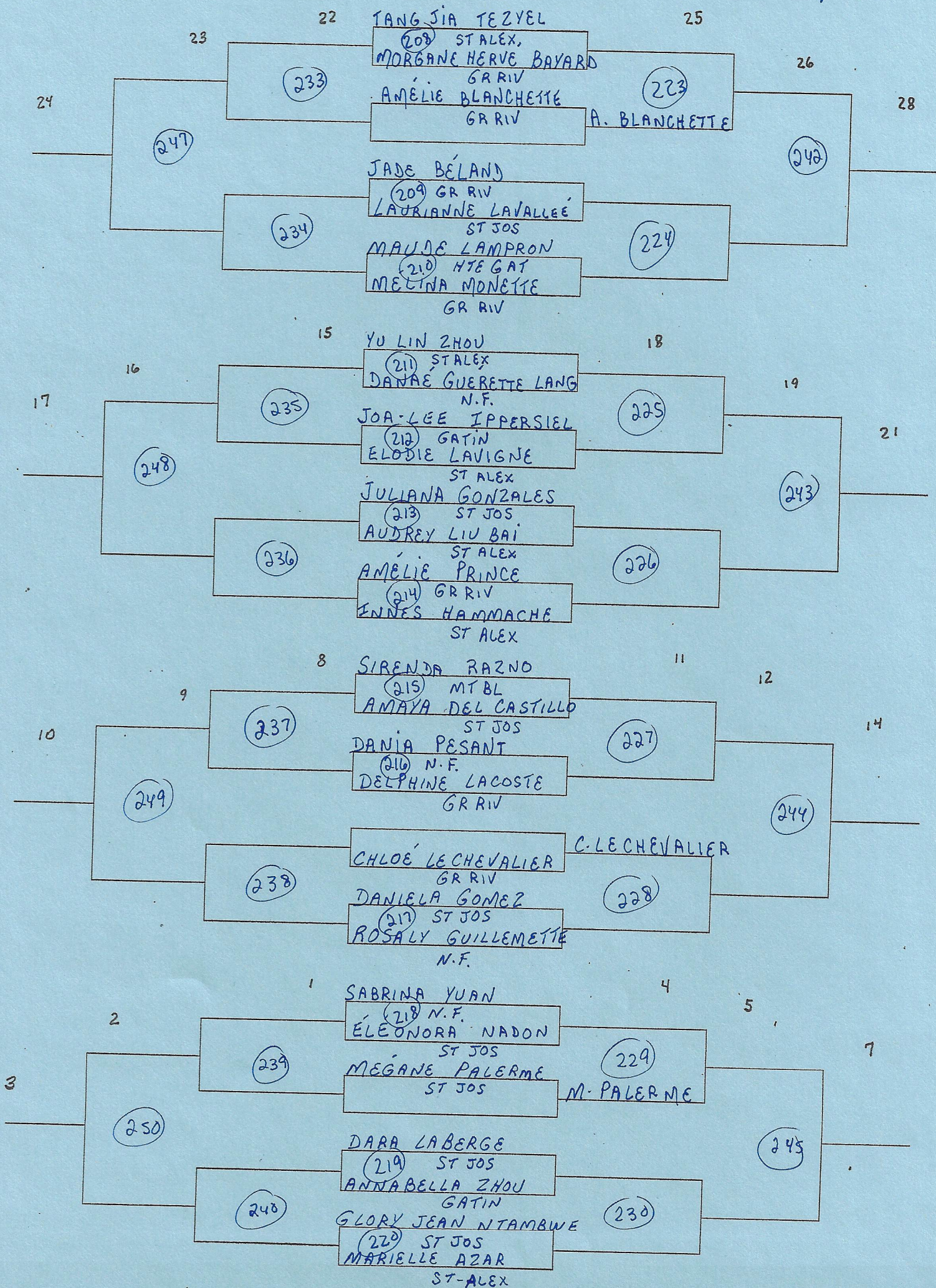

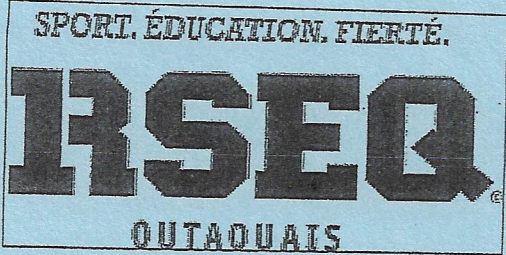

CATÉGORIE: GR. RIV
 ECOLE: DOUBLE FEM BENJ
 HEURE:
 POINTAGE: 1 MATCH 21 PTS
 SANS PROL

